



日本語

English

Digital Photo Printer

Color Stream CE1

CHC-S6245

Operation Manual

SINFONIA TECHNOLOGY CO., LTD.

<http://www.sinfo-t.jp>

Handling of this Manual

1. All rights reserved. No part of this operation manual covered by the copyright herein maybe reproduced or copied in any form or by any means, including translation, without the written permission of SINFONIA TECHNOLOGY Co., Ltd.
2. The specifications in this operation manual are subject to change without prior notice.
3. In case of having any difficulties or finding the fault in this manual, your information to SINFONIA TECHNOLOGY will be highly appreciated.

Introduction

This manual describes detailed instructions for handling of and basic operation of Digital Photo Printer CHC-S6245.

We will describe this product as “the printer” in the manual.

Read this manual thoroughly to understand how to install and operate the printer before using it.

Notice

- Keep this manual near the printer and operators can refer to this manual periodically.
- In case, lost or damaged this manual, contact your dealers.
- In the case of transfer, do not forget to put this manual together with the printer.

CONTENTS

PREFACE

Chapter 1. Important Safety Instruction	1-1
Environments	1-1
Handling Instruction	1-2
Handling Instruction for Consumable and Printed Output	1-3
Chapter 2. Installing and Set Up	2-1
Unpacking and Checking the Accessories	2-1
Parts Name and Function	2-2
Printer Status Lamps Name and Printer Status	2-3
Fixing Anti-tip Plate	2-3
Connecting Power Cable	2-4
Connecting USB Cable	2-4
Connecting Personal Computer	2-4
Setting Ink Ribbon	2-5
Loading Paper	2-6
Installing Dust Box	2-7
Transporting the Printer	2-7
Chapter 3. Routine Maintenance	3-1
Cleaning of Thermal Head, Platen and Decurl Roller	3-1
Cleaning of Outer Cover	3-2
Cleaning of Filter	3-2
Chapter 4. Error Handling	4-1
Printer Status Lamps are displayed in red	4-1
Failure Symptoms	4-1
Paper Jam	4-2
Power Supply Interrupted during Printing	4-2
When the Ribbon is snapped	4-2
Chapter 5. In order to more comfortably use	5-1
Paper Pre-Cut function can be turned off through the printer driver	5-1
For longer Printer usage	5-1
For the customers in the U.S.A.	5-2
For the customers in Canada	5-2
For the customers in Europe	5-2
Specification	6-1
After-sales Service	6-1

Chapter 1. Important Safety Instruction

This manual provides detailed instructions for the safety use of the printer. Read this manual before operating the printer to ensure to have proper use.

- ◆ In this manual, there are notes that require special attention.
- ◆ For your safety operation, Safety notices are separated as follows;



Warning: Inappropriate handling can cause the death or serious wound.



Caution: Inappropriate handling can cause the wound for the users and/or cause the physical damage.

Attention: Explanation about the cause of the trouble and the environmental condition.

- ◆ It is difficult to forecast all the danger in setting and use of the printer. Therefore, warnings in this Operation Manual, in the other documents on the printer cannot cover all the cases. In case of performing the operation or maintenance which are not described in this manual, all the concern for the safety have to be taken care of at the customer side.
- ◆ Operations and the notification for the maintenance described in this manual and other documents are for the proper use of the printer. In case of using the printer for the other purpose, all the concern for the safety has to be taken care of at the customer side.
- ◆ Do not perform the operation which are prohibited in this manual and other documents.
- ◆ The contents that cannot be printed due to a failure while using the use of this printer are not guaranteed.

Environments

To use the printer safety, please pay attention to the followings:



Caution: Do not let children to touch the printer or the cables. It can cause accidents or electric shock.



Caution: Do not place the printer under humid or dusty place. It can cause a fire, electric shock or printer problem. Do not place the printer with dust, sand and high humidity such as bathing place, bathroom, hot spring, on the street.



Caution: Do not place the printer on rickety place and/or inclined place. Printer may fall down or tumble and it can cause injury.



Warning: Do not insert or fall the metallic items or flammable items into the printer through the openings of the printer, it can cause the fire and electric shock.



Warning: Do not put vase, flowerpot, and cup with water inside or metric items. In case the water spilt or metric items fall into the printer, it can cause the fire and electric shock.



Warning: Do not block the openings of the printer. In case, the opening blocked, the heat will remain inside and it can cause the fire.

Attention: Do not place the printer under the low temperature such as ski resort, skating rink or open-air with direct sunlight.

Chapter 1. Important Safety Instruction

Handling Instruction

In handling the printer, please pay attention to the followings:



Warning: Lift the printer from its box and put it onto a flat table or desk.



Warning: At nearly 13.5Kg, the printer is too heavy to be lifted by one person.
Also please take a good care of your hands and fingers when lifting the printer from the box.



Warning: Be careful when you transport the printer on the slippery floor.



Warning: In case you drop the printer, firstly turn off the power of the printer and remove the power cable, then contact the dealers or service center. To use the printer without any checking, can cause the fire or electric shock.



Warning: Secure the power cable firmly.



Warning: This product must be grounded, and always used with only the specified power cable or the power cable accompanying this product.
If the product is used without ground, and current leakage occurs, fire or electrical shock is most likely to result, and also cause signal-receiving interference to a radio, a television receiver, and other similar electric appliances.
If the proper grounding connection is not possible, please contact to the dealers or service center.



Warning: Do not attempt to service the printer beyond the instruction specified in this document. In case, impossible to recover from the problem, please contact to the dealers or service center.



Warning: The thermal head reaches high temperature during operation but this is normal. Do not touch the thermal head.



Warning: Do not dismantle or remodel the printer.
Some sections of the printer contain a high voltage or become very hot. Ignoring this warning may cause electric shock, fire, or burns.

Attention: Touching the surface of the thermal directly can cause the damage to thermal head. When a hard object get into the printer, it can cause the damage to the printer mechanism. In such case, please do not use the printer.

Attention: At installation, appropriate interface cable will be required with your computer.

Chapter 1. Important Safety Instruction

Handling Instruction for Consumable and Printed Output

In handling the ink ribbon, paper and printed output, please pay attention to the followings:

Attention: Paper Handling

- Use the paper specified by SINFONIA TECHNOLOGY.
- Store the paper flat.
- Store the paper in a dry and dark place to avoid the direct Sunlight.
(Temperature less than 30°C, Humidity less than 60%).
- Do not touch the paper surface before

Attention: Ink Ribbon Handling

- Use the ink ribbon specified by SINFONIA TECHNOLOGY.
- Store the ink ribbon in cool place to avoid the direct sunlight.
(Temperature less than 30°C, Humidity less than 60%)

Attention: Printed Output Handling

- Store the printed output in a dark place to avoid the direct sunlight.
- Store the printed output away from the organic fluid such as benzene, thinner and alcohol which may change or deteriorate the colors.



Caution: When abandon the ink ribbon, please handle it as harmful industrial waste.



Caution: Be careful not to injure your hands with the paper edge when handling paper.



Caution: If you do not use the printer for a long time, please remove the paper and the ink ribbon from the printer.

Chapter 2. Installing and Set Up

This chapter explains the unpacking and set up of the printer.

Before proceeding to this chapter, please make sure to read Chapter 1. Important Safety Instruction.

Unpacking and Checking the Accessories

1. Open the box and remove the box containing the accessories and protection materials.

Attention: Keep the packaging materials. The box and protection materials are necessary when moving or transporting the printer. Make sure that they are retained.

2. Take out the printer by holding bottom of the printer.

Caution: This printer weighs about 13.5Kg. Please handle it carefully.
When lifting the printer, always hold bottom of printer. Otherwise, the printer may be damaged.

3. Take out the accessories from the accessory box and check the contents.

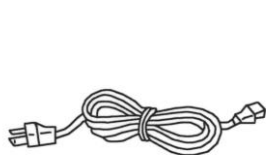

Power Cable

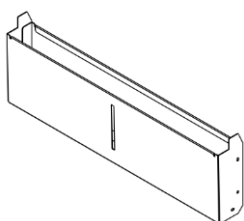

Dust Box

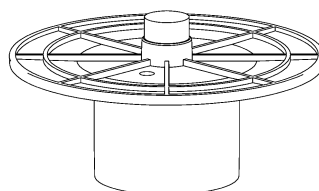

Paper Flange (White)

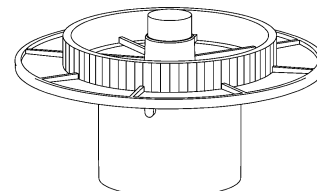

Paper Flange (Blue)

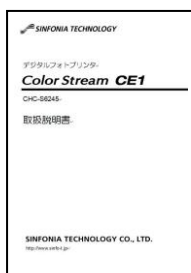

Operation Manual

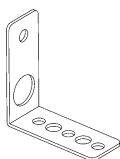

Anti-tip Plate

Caution: The CD-ROM which contains the printer driver is not included as accessories.
If you want to print with this unit, you need a personal computer which is installed the printer driver for this printer.
You can visit the SINFONIA TECHNOLOGY Driver downloads page.
For information on how to download, please refer to "Chapter 2. Installation and Set Up" on page 2-4.

Chapter 2. Installing and Set Up

Parts Name and Function

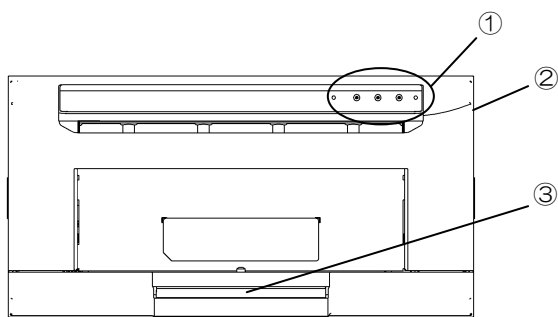

(Front View)

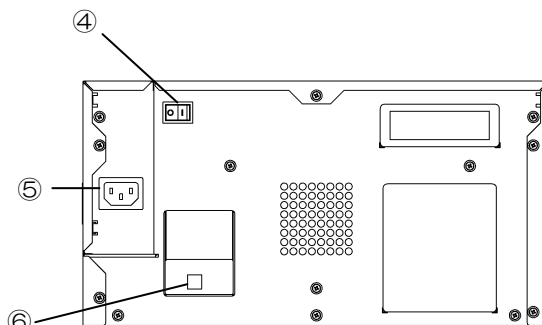

(Rear View)

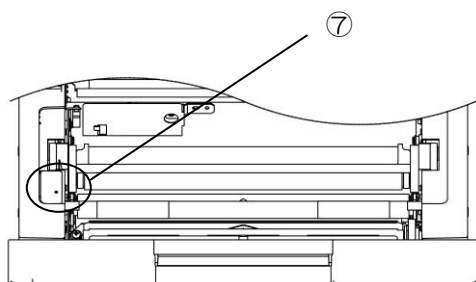

(Front Internal View)

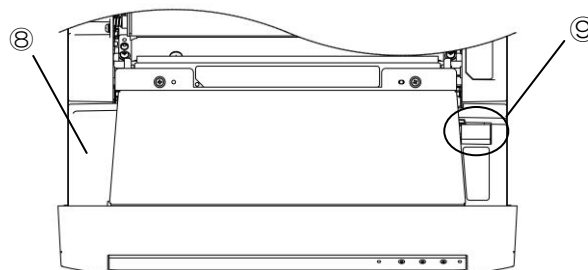

(Upper Internal View)

No.	Name	Function
①	Printer Status Lamps	Printer status display lamps are located on the panel.
②	Drawer Unit	Open the drawer unit when replacing an ink ribbon or paper, or when performing maintenance.
③	Drawer Lever	When open the drawer unit, hold this lever.
④	Power Switch	This switch turns on/off the power of the printer. When the “ ” marked side of the switch is pressed, the power is turned on. When the “o” marked side of the switch is pressed, the power is turned off. <Caution> Once the printer is turned off, wait at least 3 seconds before turning it on again.
⑤	Power Connector	To be used to connect the power cable.
⑥	USB Connector	To be used to connect the USB cable.
⑦	Paper Setting Lamp	When setting the paper, insert the paper until the lamp is lit. When the lamp blinks, remove the paper until the lamp goes off.
⑧	Open Guide Unit	Open the drawer unit when replacing paper, or when performing maintenance.
⑨	Open Guide Lever	When open the open guide unit, hold this lever.

Chapter 2. Installing and Set Up

Printer Status Lamps Name and Printer Status

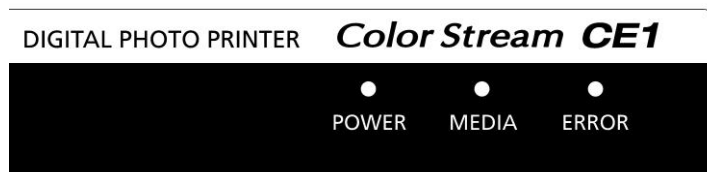

Printer status lamp display ●:on, ○:off, *:flashing

LED Display			Description
POWER	MEDIA	ERROR	
○	○	○	The power of printer is off.
*	○	○	The printer is initializing after turn on the power Thermal head is cooled/heated on printing.
●	○	○	The printer is ready If you leave the printer of ready state for 5 minutes, the printer goes into standby mode automatically.
●	○	*	The drawer unit is opened.
●	○	●	Paper jam occurred. The printer mechanical section is faulty. Trouble of printer control board.
●	*	●	The ink ribbon loaded is not supported.
●	●	●	The paper is not set. Out of the paper. The ink ribbon is not loaded. The ink ribbon is empty.
●	*	○	The printer is loading the paper or the ink ribbon.

Fixing Anti-tip Plate

1. Use a Phillips screwdriver to fix the anti-tip place to the back of the printer.

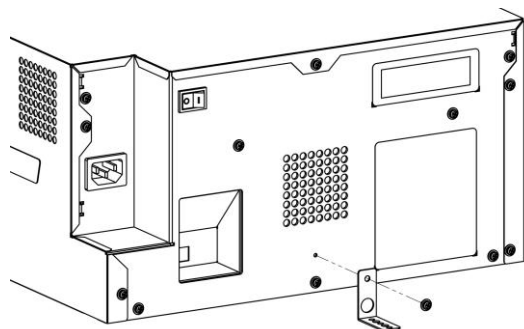

2. Install the printer with the anti-tip place and fix it onto the wooden.

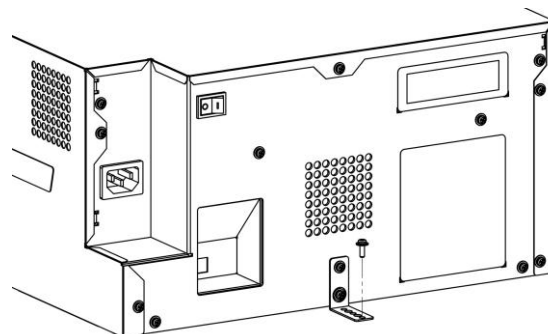

Chapter 2. Installing and Set Up

Connecting Power Cable

Insert the power cable attached to the printer into the power connector located on the rear of the printer.

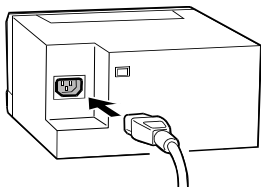

Warning: Make sure to turn off the power of the printer before inserting the power cable.



Warning: Make sure to insert the power cable correctly. If not, it can cause the fire or the printer problem.



Warning: Do not insert or remove the power cable with wet hands. It can cause the electric leakage.



Warning: Do not make any damage or any modification to the power cable. Put the heavy items on the power cable, give a strong pull to the power cable and twist the power cable can cause the fire and electric shock.



Warning: When moving the printer, make sure to turn off the power of the printer, remove the power cable in order to have no connection with other devices. Otherwise, the power cable might be damaged and it can cause the fire and electric shock. Also there is a possibility to fall down caught by the cable.



Warning: In case of not using the printer for a long time, remove the power cable for safety.



Warning: Avoid “piled up” connection. It can cause the fire and electric shock.

Connecting USB Cable

Connect the USB cable from the personal computer to the USB connector located on the left rear side of the printer.

Be sure to insert the USB cable all the way.

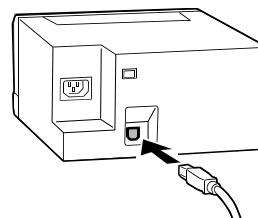

Attention: To remove the USB cable, make sure that the printer is in the waiting status. Removing the USB cable during data transfer may not be able to print data correctly.

Connecting Personal Computer

1 . Visit the following website, and download the Printer Driver from Color Stream CE1(CHC-S6245)/Driver Download.

<http://www.sinfo-t.jp/eng/printers.php>

2 . Follow the installation instructions which is contained in the printer driver package, install the printer driver on your personal computer.

Chapter 2. Installing and Set Up

Setting Ink Ribbon

1. Remove dust box.

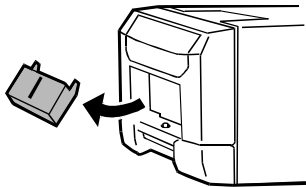

2. Carefully lift the drawer lever and pull the drawer unit.

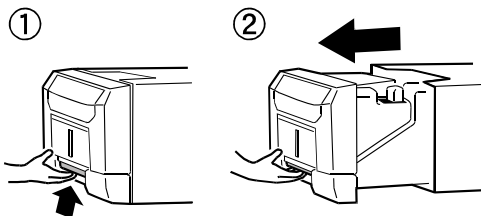

Attention: Do not open the drawer unit quickly or with unnecessary force. Do not press the drawer unit or place a heavy object other than paper after opening the drawer unit.

4. Take the slack the ink ribbon by turning the ink ribbon supply core.

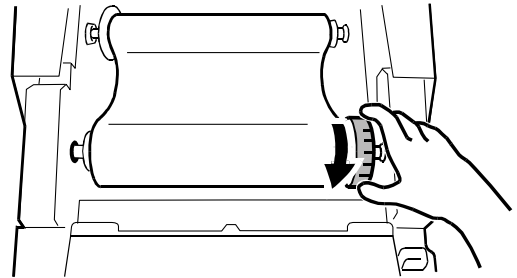

3. Set the ink ribbon to drawer unit as shown

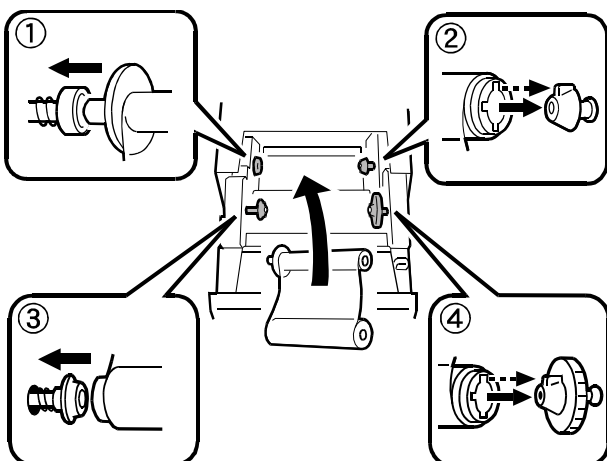

Chapter 2. Installing and Set Up

Loading Paper

Turn on the power of the printer by pressing " | " on the power switch.

1. In the drawer unit pull out, pull the lever to open the open guide unit. Pull out the drawer unit and pull the lever to open the open guide unit.

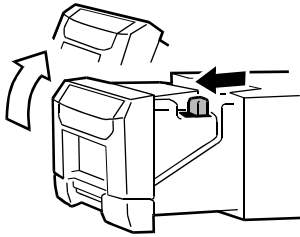

Attention: Do not open the drawer unit quickly or with unnecessary force. Do not press the drawer unit or place a heavy object other than paper after opening the drawer unit.

2. Install the paper flange (white) and paper flange (blue).

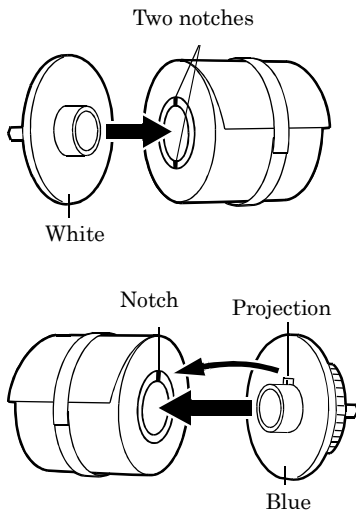

Caution: The paper is not set correctly if there is a gap of about 5mm ~ 10mm between the paper flange and paper. Match the notch of the paper flange and the notch of the paper core by rotating the paper flange.

3. Set the paper in the printer. Set the paper by matching the color of the paper flange and the color of the holder. After setting the paper, remove the seal from the paper.

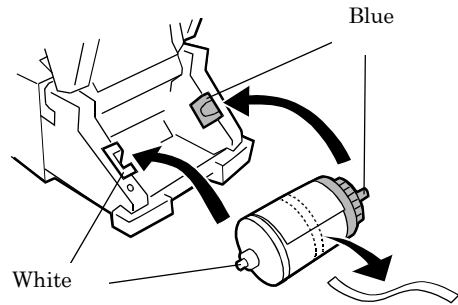

4. Insert the edge of paper under the guide roller by rotating the paper flanges. Insert the paper until the PAPERSET lamp is lit.

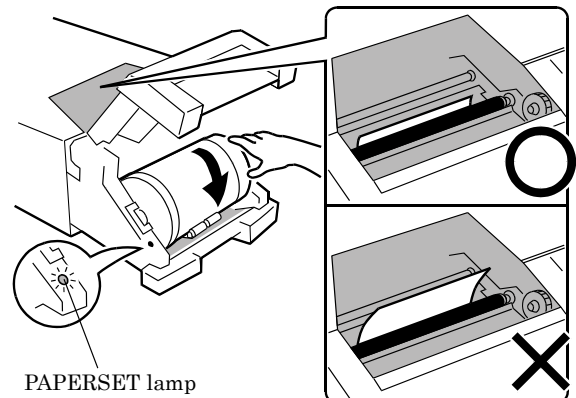
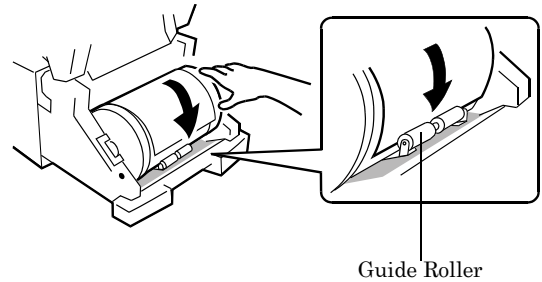

Caution: The aim of the paper set position is the position that looks about 10mm of paper tip. Please do not insert too.

Chapter 2. Installing and Set Up

5. Close the open guide unit.

When close the open guide unit, press on the center of the open guide unit.

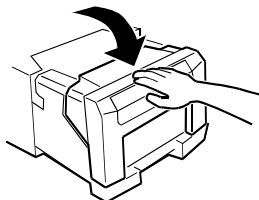

6. Close the drawer unit.

In case that both the paper and the ink ribbon are loaded into the printer and the drawer unit is closed, initialization starts and four sheets of paper are ejected automatically.



Caution: Close the front cover carefully so as not to catch your fingers.
Close the drawer unit and later to close the open guide unit.
Do not close the drawer unit and the open guide unit quickly.

Installing Dust Box

Insert the claw of the dust box first and insert the projected section of the printer in the hole at the bottom of the dust box.

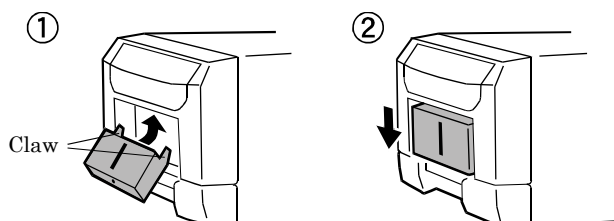

Transporting the Printer

The following cautions are necessary in transportation of the printer. Since an incorrect transportation method causes a printer fault, follow the correct method.

1. Remove the ink ribbon and paper from the printer before transporting the printer.
If the ink ribbon or paper cannot be removed due to a fault, consult with the distributor.
2. Use a genuine box.
If the box used at the purchase cannot be used, consult with your distributor and purchase a new box.

Chapter 3. Routine Maintenance

Cleaning of Thermal Head, Platen, and Decurl Roller

By using thermal transfer technology, daily maintenance is not really necessary if the printer is being use properly.

However, in order to keep the best print quality, it is recommended to do the cleaning of Thermal Head, Platen, and Decurl Roller once in a month.



Caution: Make sure that the power is turned off before starting cleaning. Thermal Head reaches high temperature just after printing. Do not touch directly by hand. Make sure that the thermal head has been sufficiently cooled down before starting cleaning.

When fingerprint stick to the heat element, it can damage the Thermal Head. Do not touch directly by hand.

Be careful not to be hurt by the projections of the printer.

1. Using gauze, clean the heat element (glass bar) of the thermal head with isopropyl alcohol or ethyl alcohol.

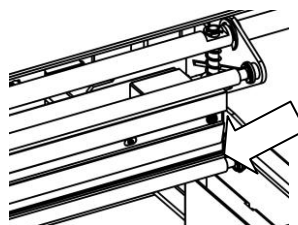
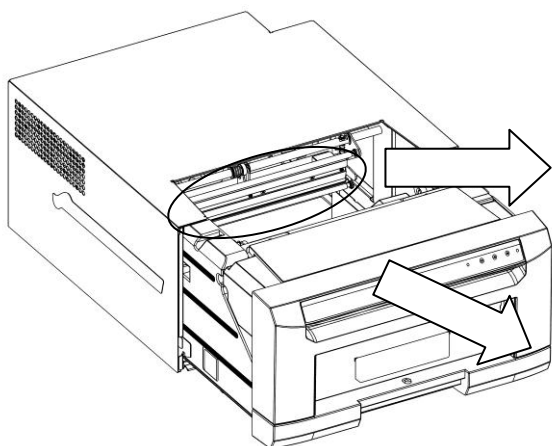

2. Using gauze dipped with isopropyl alcohol or ethyl alcohol, clean the edge of the peeling roller.

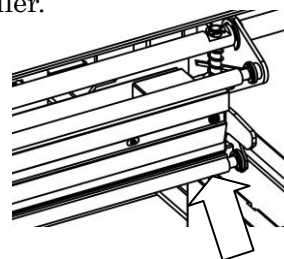

3. Using gauze dipped with isopropyl alcohol or ethyl alcohol, clean the rubber section of the platen roller

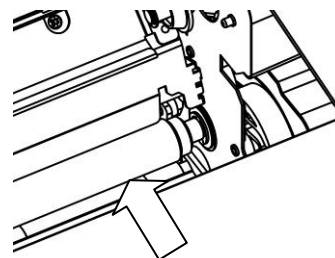
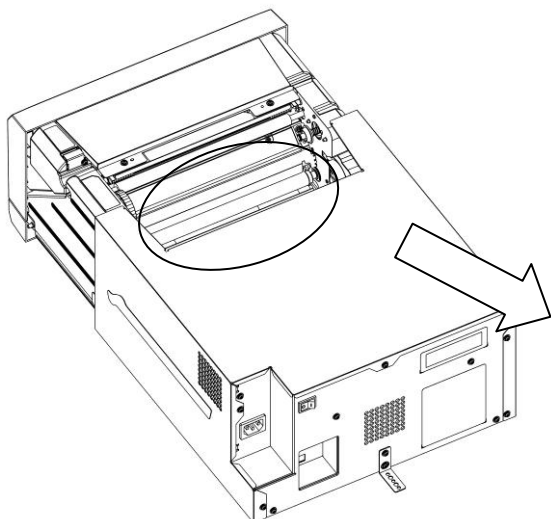

Chapter 3. Routine Maintenance

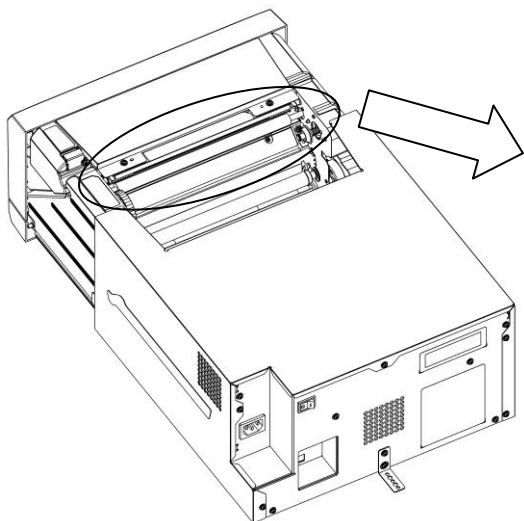

4. Using gauze dipped with isopropyl alcohol or ethyl alcohol, clean the rubber section of the decurl roller

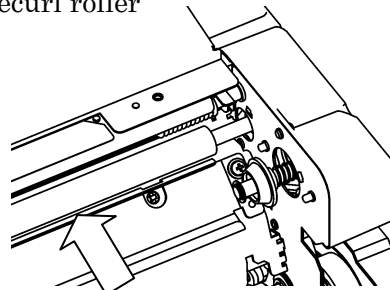

Attention: Printing should be performed after the alcohol dried up completely (approx. 5 minutes)

Cleaning of Outer Cover

Wipe the printer outer cabinet with a soft cloth.

If the stains are not removed, wet the cloth and apply weakened neutral Detergent to it.



Warning: In case, the foreign substance get into the printer, turn off the power of printer, remove the power cable and contact the dealers or service center. Continuous use of the printer under such condition can cause the fire and electric shock.



Warning: Continuous use under the abnormal condition such as high temperature, smoke and strange smell can cause the fire and electric shock. Turn off the power and make sure to remove the power cable, then contact the dealers or service center.



Caution: Do not use volatile solvents or spray insecticide on the printer outer cabinet. Otherwise, discoloration or crack may result.

Cleaning of Filter

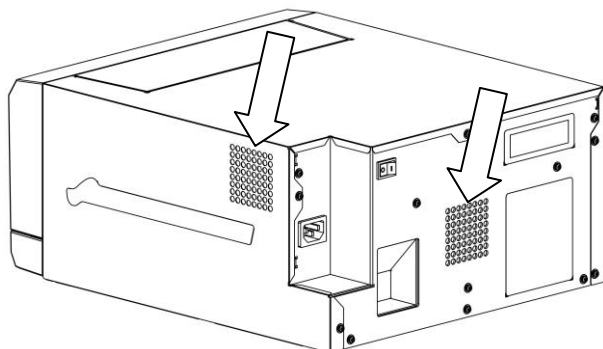

If the dust collects on the openings, clean it with vacuum cleaner

Chapter 4. Error Handling

Printer Status lamps are displayed in red

When the error happens, the details of the error can be confirmed with the printer status lamps.

Printer Status Lamps and Paper Setting Lamp display ●:on、○:off、*:flashing

/ : Indicates that irrespective lit

LED Display			Status	Corrective Action
MEDIA	ERROR	PAPERSET		
○	*	/	The drawer unit is opened.	Close the drawer unit.
○	●	*	Paper jam occurred.	Remove the paper. If paper jam occurs frequently, consult with the service center.
○	●	/	Trouble of printer control board. The printer mechanical section is faulty.	If it occurs frequently, consult with the service center.
*	●	/	The ink ribbon set is not supported.	Ink ribbon or printer abnormality is assumed. Consult with the Service Department.
●	●	○	Paper is not set. Out of paper.	Set paper. Replace paper.
●	●	●	The ink ribbon is not loaded. Ribbon Empty.	Set the ink ribbon. Replace the ink ribbon.

Failure Symptoms

When detecting a failure symptom, check the printer using the following table.

Symptom	Action
Power is not turned on.	<ul style="list-style-type: none"> • Check if the power cable is connected to the plug socket or the printer.
The personal computer does not recognize the printer.	<ul style="list-style-type: none"> • Check if the USB cable is connected to the personal computer or printer.
The printer does not become ready.	<ul style="list-style-type: none"> • Check if the drawer unit is closed. • Check if paper is jammed in the printer. • When the paper setting lamp is blinking, remove the edge of the paper until the paper setting lamp goes off.
The drawer unit does not open.	<ul style="list-style-type: none"> • Check if the printer is installed in a flat location. • Check if any object is placed in front of the front cover.
A straight stripe area is not printed.	<ul style="list-style-type: none"> • The thermal head may be dirty. Clean the thermal head as described in Chapter 3, "Routine Maintenance". • If the blank area remains after cleaning the thermal head, the head may have been disconnected. Consult with the Service Department.
Dotted areas are not printed.	<ul style="list-style-type: none"> • The cleaning roller may be dirty. Clean the thermal head as described in Chapter 3, "Routine Maintenance".

Chapter 4. Error Handling

Paper Jam

1. Open the drawer unit.
2. Cut off the folded section or printed section with scissors.

When the paper is folded inside of the printer, pull it out slowly.

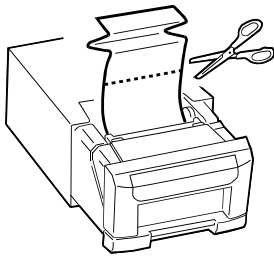

Attention: If the paper is can not pulled out to the Ribbon side, pull out it to the Roll paper side following the instruction in Step 3 and Step 4.

If the paper is pulled out to the Ribbon side by force, the printer may break down.

3. Open the open guide unit.
4. Pull out the paper until the paper setting lamp goes off.

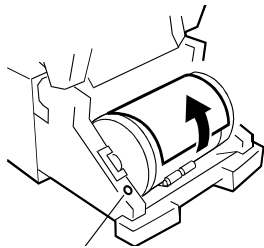

PAPERSET lamp

Attention:

- If the paper is used without cutting off the folded section or printed section, paper jam occurs again or the ink ribbon may snap during printing. Always cut off the creased section or printed section of the paper.
- Cut off the paper straight and at right angles to the roll paper direction.
- If paper jam occurs frequently, a defect in the mechanical section is assumed. Consult with the service center.

Power Supply Interrupted during Printing

In case, power supply interrupted during the printing, Thermal Head will be kept pushing to Platen. Leaving this situation for a long time, shape of Platen can be warped. In order to avoid this situation, please follow the instruction below.

1. Turn off the power of the printer.
2. Turn on the power for 3 or more seconds after turning off the power.
3. Paper Jam is displayed on the printer status lamps, open the front cover and take the necessary action according to the instruction provided in 4-2, "Paper Jam".

When the Ribbon is snapped

1. Remove the ink ribbon.
2. Stick the broken part of the ribbon with a tape.

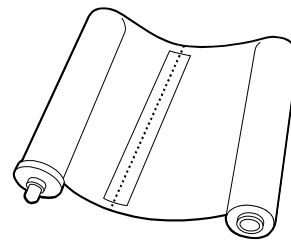

3. Turn the ribbon on the rewinding side and rewind the taped section completely.

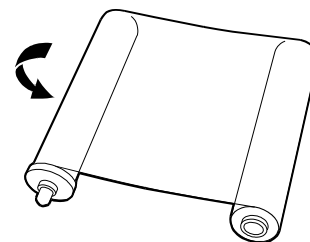

Chapter 5. In order to more comfortably use

Paper Pre-Cut function can be turned off through the printer driver.



Caution: Dust on the surface of the paper may damage the thermal head.
Clean the dust on the paper surface and install the paper roll into the printer.



Caution: Clean the finger print on the paper surface to avoid the finger print on the print image.



Caution: Paper may be installed and fixed on improper direction, but maybe oblique direction.



Caution: Not straight cut of paper edge may cause paper jam. To prevent paper jam, recommend to use pre-cut function of paper roll. In case of paper jam or print incompleteness, reinstall the paper roll and use pre-cut function.

For longer Printer usage



Caution: Printing continuous pattern of high density image in limited part may cause uneven density print. Recommend not to print those images continuously.

Chapter 5. In order to more comfortably use

For the Customers in the U.S.A.

FCC WARNING

Changes or modifications not expressly approved by the party responsible for compliance could void the user's authority to operate the equipment.

Note: This equipment has been tested and found to comply with the limits for a Class A digital device, pursuant to part 15 of the FCC Rules. These limits are designed to provide reasonable protection against harmful interference when the equipment is operated in a commercial environment. This equipment generates, uses, and can radiate radio frequency energy and, if not installed and used in accordance with the instruction manual, may cause harmful interference to radio communications. Operation of this equipment in a residential area is likely to cause harmful interference in which case the user will be required to correct the interference at his own expense.

For the Customers in Canada

This device complies with Industry Canada licence-exempt RSS standard(s). Operation is subject to the following two conditions: (1) this device may not cause interference, and (2) this device must accept any interference, including interference that may cause undesired operation of the device.

Le présent appareil est conforme aux CNR d'Industrie Canada applicables aux appareils radio exempts de licence.

L'exploitation est autorisée aux deux conditions suivantes : (1) l'appareil ne doit pas produire de brouillage, et (2) l'utilisateur de l'appareil doit accepter tout brouillage radioélectrique subi, même si le brouillage est susceptible d'en compromettre le fonctionnement.

For the Customers in Europe

This product shall not be used in the residential area.

This is a Class A product. In a domestic environment, this product may cause radio interference in which case the user may be required to take adequate measures.

Sinfonia Technology Co., Ltd. hereby declares that this CHC-S6245-5 is in compliance with the essential requirements and other relevant provisions of Directive 1999/5/EC.

The manufacturer of this product is Sinfonia Technology Co., Ltd.
1-1-30, Shiba-daimoncho, Minato-ku, Tokyo, Japan.

If you want to dispose this product, do not mix with general household waste. There is a separate collection system for used electronics products in accordance with legislation under the WEEE Directive (Directive 2002/96/EC) and is effective only within European Union.

For details, consult your dealer.



Specification

Product name		Color Stream CE1	
Model name		CHC-S6245-5	
Printing method		Dye sublimation thermal transfer	
Resolution		12 dots/mm (300 dpi)	
Print sizes		203 mm x 305 mm (8 x 12 size) 203 mm x 254 mm (8 x 10 size) 203 mm x 203 mm (8 x 8 size) 203 mm x 152 mm (8 x 6 size) 203 mm x 127 mm (8 x 5 size) 203 mm x 102 mm (8 x 4 size)	
Print media		Paper 203 mm (8 in.) width roll paper for print 120 sheets/roll (in case of 8 x 10 size prints) 100 sheets/roll (in case of 8 x 12 size prints)	
		Ink ribbon	8 x 10 size ink ribbon 120 images/roll
			8 x 12 size ink ribbon 100 images/roll
Operating environment	temperature	10 to 35 degrees C	
	humidity	20% to 80% (RH) (There must be no condensation in both cases)	
Paper feeding		Roll paper feed (Roll to Cut method)	
Dimensions		Width, 330 mm	
		Depth 395 mm	
		Height 174 mm	
Weight		13.5 kg or less (Excluding consumables and accessories)	
Power voltage		100 to 240 V AC (Automatic switching)	
Power consumption		Less than 400 W / 4.0 A at 100 V AC Less than 400 W / 2.0 A at 220 V AC	
Interface		USB 2.0	
Buffer Memory		64 MB	

The above specifications are subject to change without notice.

After sales Service

Contact your dealers or service center for the details about after-sales service.



YTE8-J0556

Prepared date : Apr 5, 2013

Revision date : Nov 12, 2013

Revision Number : Revision 3